

Torres de Aquecimento

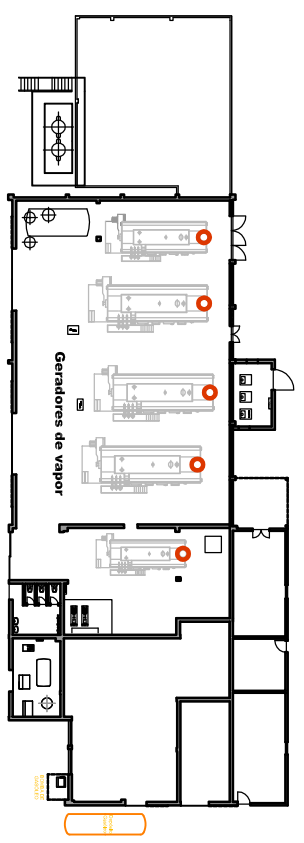

PRÉ-AQUECIMENTO CATELLI EL DORADO

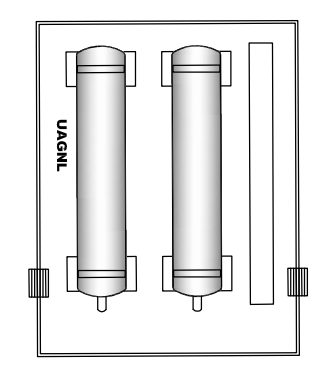
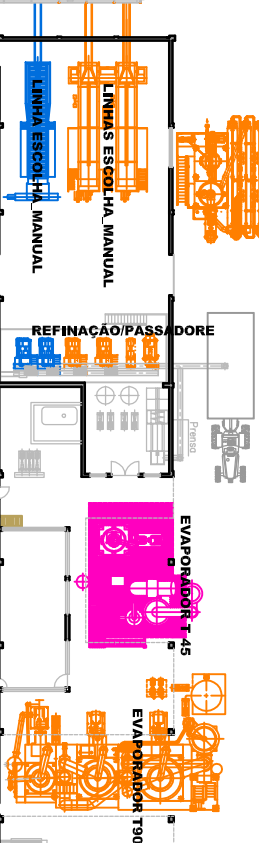

EVAPORADOR 1-45

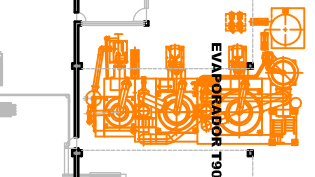

EVAPORADOR 190

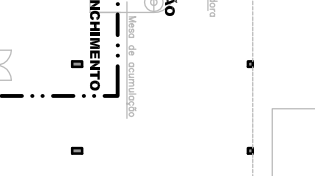

PALETIZAÇÃO

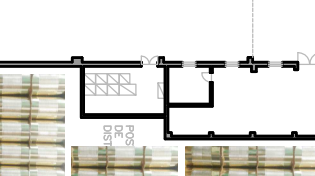

ESTERILIZADOR E ENCHIMENTO

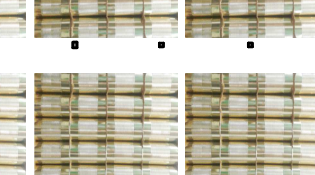

ESTERILIZADOR E ENCHIMENTO

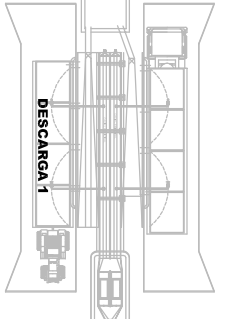

ELEVAÇÃO TOMATE FRESCO

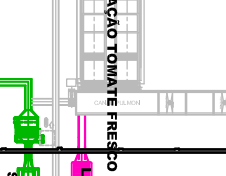

LINHA ESCOLHA MANUAL

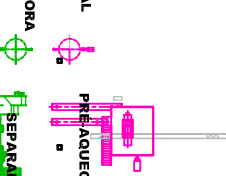

REFINAÇÃO/PASSADORE

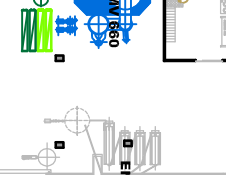

EVAPORADOR MV 160

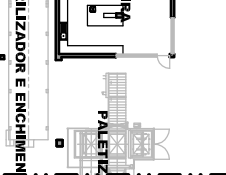

PRE-AQUECEDORES

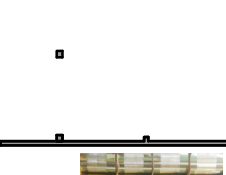

SELETOR DE ESP. CALIBRADORA



SEPARADOR PELES

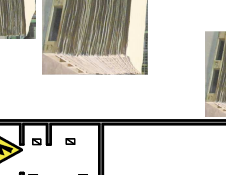

CORTADORA CUBOS TANQUES MISTURA

LINHA ESCOLHA MANUAL



REFINAÇÃO/PASSADORE

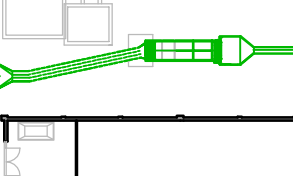

EVAPORADOR MV 160

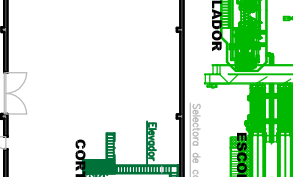

PRE-AQUECEDORES

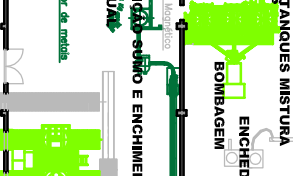

SELETOR DE ESP. CALIBRADORA

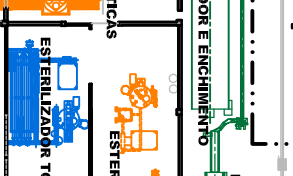

SEPARADOR PELES

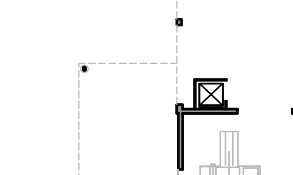

CORTADORA CUBOS TANQUES MISTURA

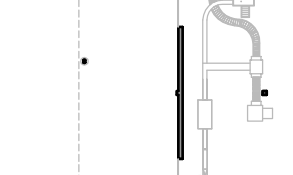

ENCHEDORA E PALETIZADORA

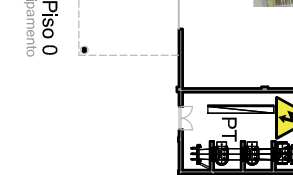

ENCHEDORA E PALETIZADORA

ENCHEDORA E PALETIZADORA



ENCHEDORA E PALETIZADORA

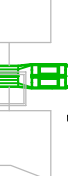

ENCHEDORA E PALETIZADORA



ENCHEDORA E PALETIZADORA



ENCHEDORA E PALETIZADORA



ENCHEDORA E PALETIZADORA



ENCHEDORA E PALETIZADORA



ENCHEDORA E PALETIZADORA



ENCHEDORA E PALETIZADORA

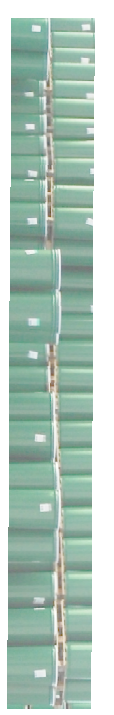
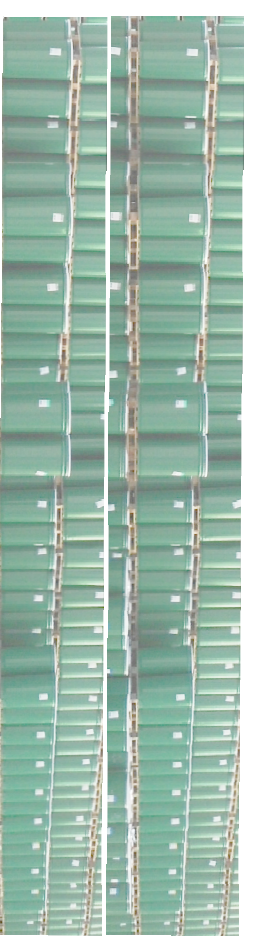
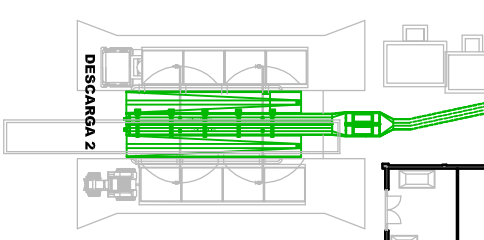
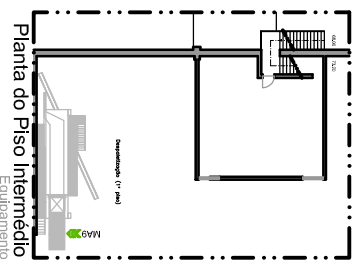

Planta do Piso 0

Equipamento

Legenda de Cores

- Linha 1 e 2_ produção de concentrado de tomate
- Linha 3_ Produção de refinado de tomate/passata
- Linha 4_ produção de concentrado de tomate
- Linha 5_ Linha de produção de tomate em cubos [tomate pelado]
- Linha 5a_ produção de cubos não assépticos
- Linha 5b_ produção de cubos não assépticos
- Linha de produtos específicos [Fora da campanha]



Trovesa dos Arrozeiros, n.º 62
 Parceiros de São João
 2350-214 Parceiros de Igreja
 telf: 917882462
 telf: 249835190
 fax: 249835550
 e-mail: geral@ambialca.pt
 www.ambialca.pt

requerente
 SOPRAGOL, S.A.

processo
 SOP_PCIP 02

desenho
 02

local
 Montinho de Boixo - MORA

data
 Março 2015

escala
 1:550

fase
 Licenciamento de Unidade Industrial

especialidade
 PCIP

anexo
 AN4.9

contém
 RNT_Planta de Equipamentos